

MICROBURST^{®/MD}

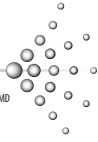

DUET

Dispenser Instructions

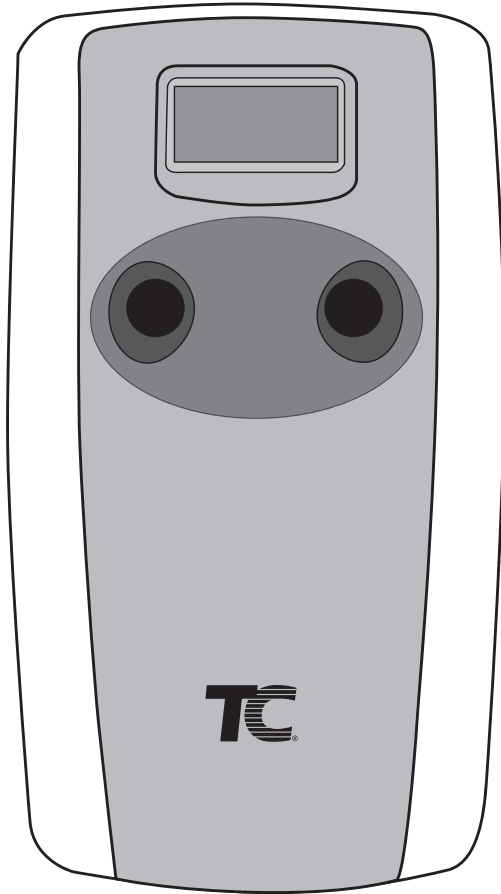

Clean
management

TC[®]

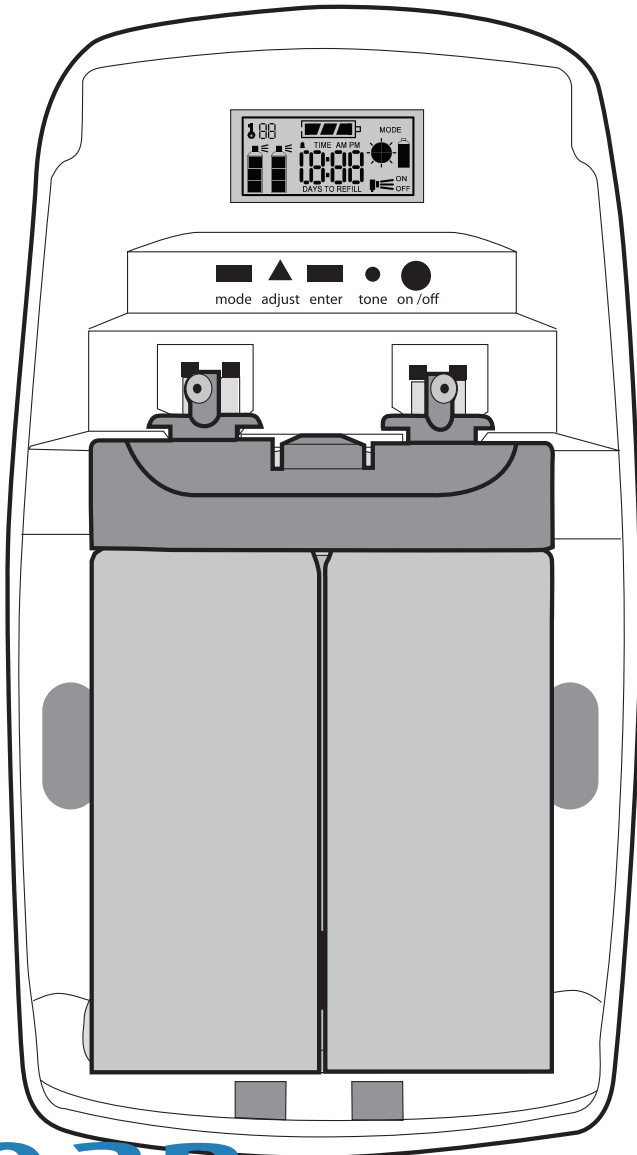
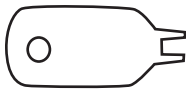



Install Dispenser

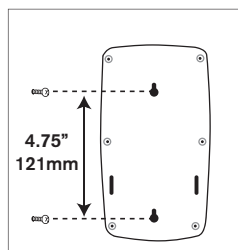
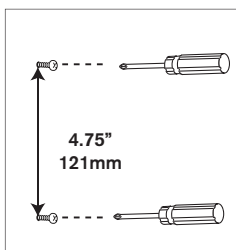
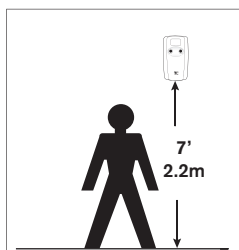

Battery Change (2 C-Alkaline/MN1400/LR14)

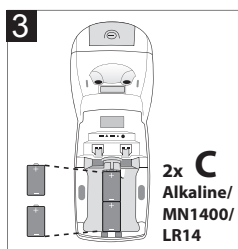
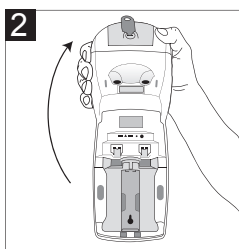
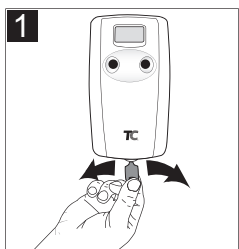

Change Refill

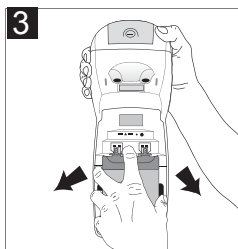
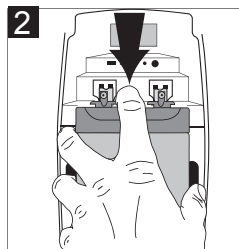
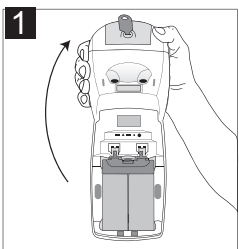
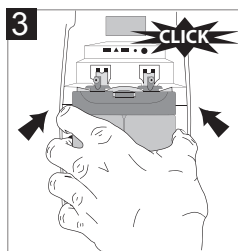
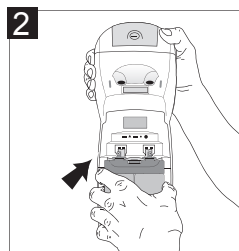
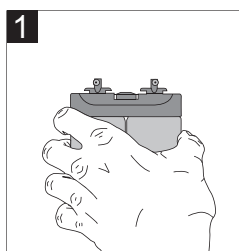

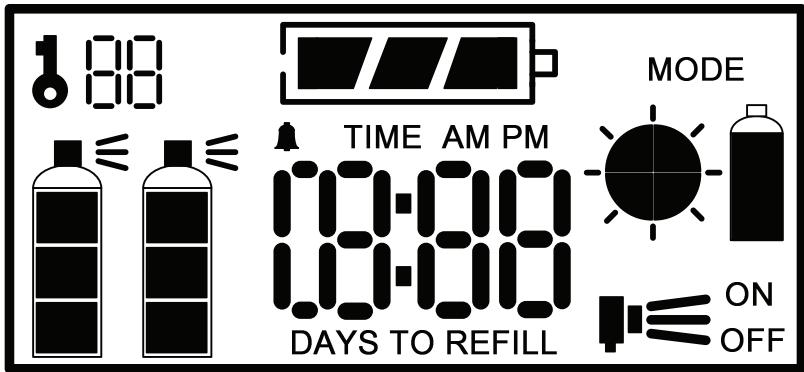

- 
mode
- 
adjust
- 
enter
- 
tone
- 
on/off

Operation Instructions

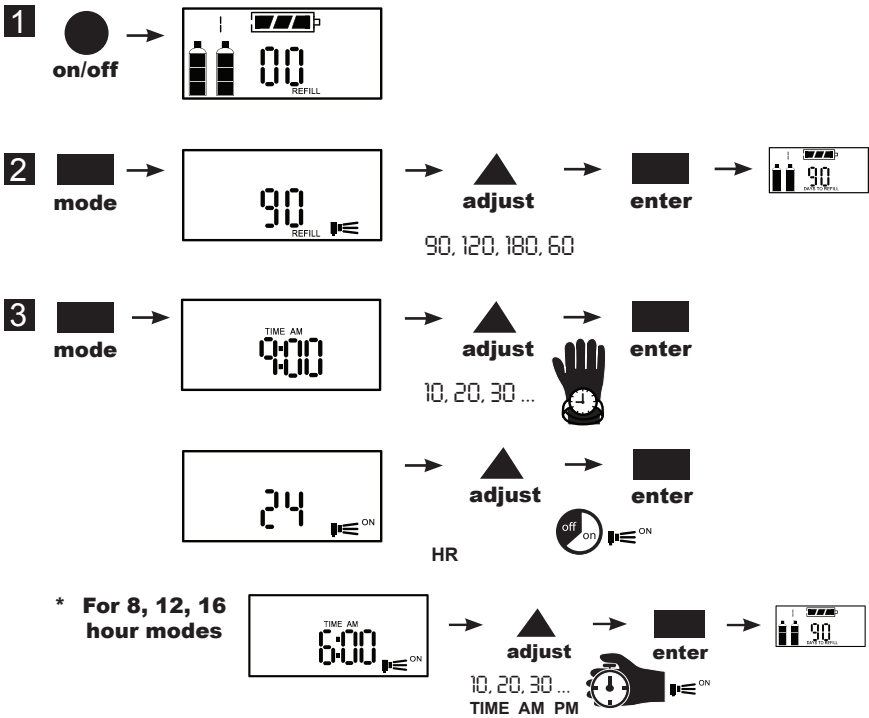

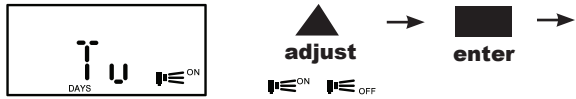
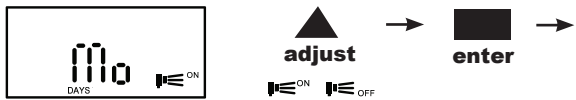
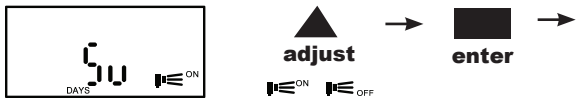
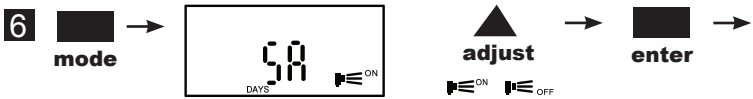
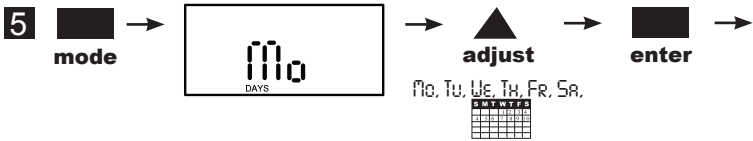
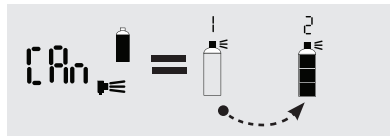
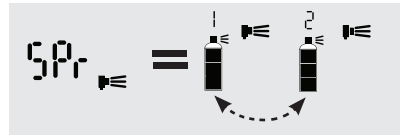
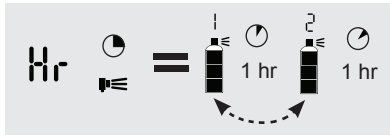
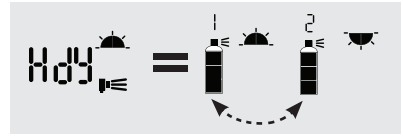
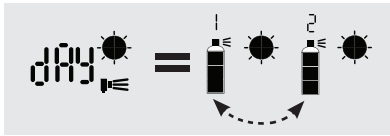
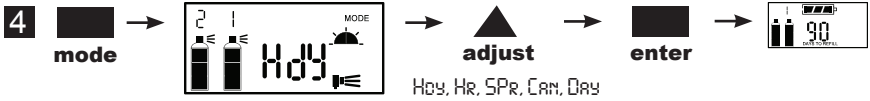

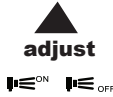
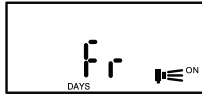
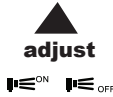
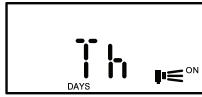

Alarm On/Off

tone

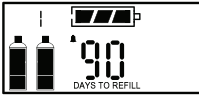

tone

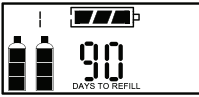

Switch Display

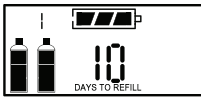

Test

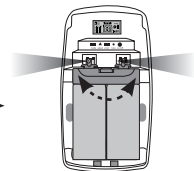
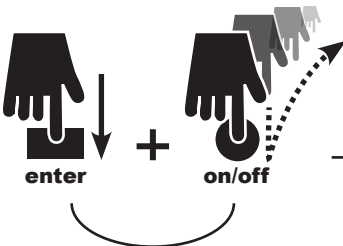



EN For dispenser only

Waste Electrical and Electronic Equipment (WEEE) Directive

Directive 2002/96/EC of the European Parliament and of the Council. The symbol (above) is shown on this product. It indicates that the product should not be disposed of with regular household waste, but should be disposed of separately for the appropriate recycling to take place.

FR Pour unité de distribution uniquement.

Directive pour la décharge de matériel électrique et électronique (WEEE)

Directive 2002/96/EC du Parlement Européen et du Conseil. Le symbole (ci dessus) se trouvant sur ce produit indique qu'il ne faut pas le mettre dans les poubelles ménagères mais le déposer dans un endroit spécialement adapté à son recyclage.

DE Nur für Spender

Richtlinie über Elektro- und Elektronikaltgeräte (WEEE-Richtlinie)

Richtlinie 2002/96/EG des Europäischen Parlaments und des Rates. Das Produkt ist mit dem (obigen) Symbol gekennzeichnet. Es weist darauf hin, dass das Produkt nicht mit dem normalen Haushaltsmüll, sondern getrennt zwecks entsprechend angemessenem Recycling zu entsorgen ist.

NL Alleen voor dispenser

Richtlijn Afval van elektrische en elektronische apparatuur (WEEE)

Richtlijn 2002/96/EG van het Europees parlement en de Raad. Het (bovenstaande) symbool wordt op dit product getoond. Dit geeft aan dat dit product niet met het normale huishoudafval moet worden afgevoerd maar gescheiden moet worden ingezameld voor toepasselijke recycling.

IT Solo per distributore

Direttiva Attrezzatura Rifiuto Elettrico ed Elettronico (WEEE)

Direttiva 2002/96/CE del Parlamento Europeo e del Consiglio. Il simbolo (sopra) viene illustrato sul prodotto. Esso indica che il prodotto non deve essere smaltito con i normali rifiuti domestici, ma deve essere smaltito separatamente per effettuare il corretto riciclaggio.

ES Para el dispensador solamente

Directiva sobre equipos de eliminación de residuos electrónicos y electrónicos (WEEE)

Directiva 2002/96/CE del Parlamento y del Consejo Europeo. Este producto muestra el símbolo (anterior). Este símbolo indica que el producto no debe eliminarse con los residuos domésticos normales, sino que debe eliminarse por separado a fin de poder reciclarse de la forma correcta.

PT Só para o distribuidor

Norma de Procedimento para Resíduo de Equipamento Elétrico e Eletrônico (WEEE)

[Waste Electrical and Electronic Equipment] Norma de Procedimento 2002/96/EC do Parlamento Europeu e do Conselho O símbolo (acima) é exibido neste produto, indicando que este produto não pode descartado em lixo doméstico comum, mas, separadamente a fim de que seja reciclado adequadamente.

DA Må kun anvendes i automater.

Direktiv for afskaffelse af elektrisk og elektronisk udstyr (AEEU)

Direktiv 2002/96/EC af det europæiske parlament og Europarådet. Symbolet ovenfor er vist på dette produkt. Det betyder at produktet ikke må kasseres med almindeligt husholdningsaffald, men skal afskaffes separat på de steder hvor genbrug finder sted.

NO Kun for dispenser

Direktivet om kasserte elektriske og elektroniske produkter (EE-avfall)

Direktiv 2002/96/EF vedtatt av EU-parlamentet og Rådet. Symbolet (over) er synlig på dette produktet. Det informerer om at produktet ikke skal kasseres sammen med vanlig husholdningsavfall, men separat, slik at den nødvendige gjenvinningen kan finne sted.

FI Vain pumpuille

Sähkö- ja elektroniikkaromua koskeva direktiivi (SER-direktiivi)

Euroopan parlamentin ja neuvoston direktiivi 2002/96/EY. Tuotteessa on yllä oleva merkintä. Merkintä ilmoittaa, ettei tuotetta saa hävittää sekajätteenä, vaan se tulee erotella kierrätyksen mahdollistamiseksi.

SV Endast för fördelaren.

Riktlinje om Avfall från Elektrisk och Elektronisk Utrustning (WLLL)

Riktlinje 2002/96/EC av det europeiska parlamentet och Rådet. Symbolen (ovan) är visad på denna produkt och anger att produkten inte får bortföras tillsammans med allmänt hushållsavfall utan skall bortföras särskilt för att lämplig återvinning skall ske.

EL Μόνο για το διανομέα

Οδηγία Ηλεκτρικού και Ηλεκτρονικού Εξοπλισμού Αποβλήτων (WEEE)

Οδηγία 2002/96/ΕΚ του Ευρωπαϊκού Κοινοβουλίου και του Συμβουλίου. Το σύμβολο (ανωτέρω) παρουσιάζεται σε αυτό το προϊόν. Δείχνει ότι το προϊόν δεν πρέπει να πετάγεται μαζί με τα συννηθισμένα οικιακά απόβλητα, αλλά πρέπει να πετάγεται χωριστά για να πραγματοποιείται η κατάλληλη ανακύκλωση.

- CS** Pouze pro dávkovač
Směrnice o starých elektrických a elektronických přístrojích – Směrnice WEEE
Směrnice Evropského parlamentu a Rady č. 2002/96/ES. Na tomto výrobku je zobrazen výše uvedený symbol. Označuje, že tento výrobek nesmí být likvidován spolu s normálním komunálním odpadem, ale je nutno jej shromažďovat zvlášť pro provedení vhodné recyklace.
- HU** Kizárólag adagolókok számára
Elektromos és elektronikus berendezések hulladékainak (WEEE) irányelve
Az Európai Parlament és Tanács 2002/96/EK irányelve. A szimbólum (lásd fent) szerepel ezen a terméken. A szimbólum azt jelenti, hogy a termék nem szabad a szokásos háztartási hulladékok közé keverni, hanem a megfelelő újrahasznosítás érdekében, külön kell ártalmatlanítani.
- PL** Tylko dla dozownika
Dyrektywa dotycząca odpadów elektrycznych i Sprzętu elektrycznego (WEEE)
Dyrektywa 2002/96/WE Parlamentu Europejskiego i Rady Powyższy symbol jest ukazany na tym produkcie. Wskazuje on, iż produkt nie powinien być wyrzucany razem ze zwykłymi odpadami lecz usunięty oddzielnie w celu przeprowadzenia odpowiedniego odzysku.
- SK** Iba pre dávkovač
Smernica o odpade z elektrického a elektronického zariadenia (OEEZ)
Smernica 2002/96/ES Európskeho parlamentu a Rady. Na tomto výrobku je zobrazený tento symbol (uvedený vyššie). Označuje, že výrobok by nemal byť likvidovaný spolu s bežným odpadom z domácnosti, ale mal by byť likvidovaný osobitne, vhodným spôsobom recyklácie.
- BG** Предназначено за контейнера
Директива относно Отпадъците от Електрическо и Електронно Оборудване.
Директива 2002/96/ЕО на Парламента и Съвета на Европа. Този символ [виж по-горе] се вижда върху продукта. Това означава, че продуктът не трябва да се изхвърля заедно с обикновените домакински отпадъци, а трябва да се изхвърли отделно, за да се преработи по съответен начин.
- ET** Ainult jaoturi kohta
Elektri- ja elektroonikaseadmete jäätmete direktiiv (WEEE)
Euroopa Parlamendi ja nõukogu direktiiv 2002/96/EÜ elektri- ja elektroonikaseadmete jäätmete kohta. Ülaloodud tähis on kujutatud tootel. See tähendab, et toodet ei tohi kasutuselt kõrvaldada nagu tavaliselt olmejäätmeid, vaid see tuleb utiliseerida eraldi, kasutades vastavaid võtteid teisele toorme eraldamiseks.
- LV** Tikai dozatoram
Direktīva par elektrisko un elektronisko iekārtu atkritumiem (EEIA)
Direktīva Parlamenta un Padomes direktīva 2002/96/EK. Uz šī produkta ir parādīts šis simbols (skat. augstāk). Tas norāda uz to, ka produktu nedrīkst izmest kopā ar parastiem sadzīves atkritumiem, un tas ir jānodod atkritumos atsevišķi, atbilstoši atbilstošajai pārstrādei.
- LT** Tik automatams
Europos Parlamento ir Tarybos direktyva dėl elektrinių ir elektroninių atliekų (WEEE)
2002/96/EB Europos Parlamento ir Tarybos direktyva. Aukščiau minimas ženklas yra nurodytas ant šio produkto. Tai reiškia, kad produktą negalima išmesti kartu su įprastinėmis buitinėmis atliekomis, o tik atskirai atitinkamam pakartotinam panaudojimui.
- RO** Numai pentru container
Directiva cu privire la Deșeurile Aparatură Electrică și Electronică
Directiva 2002/96/EC a Parlamentului și Consiliului European. Acest simbol (vezi mai sus) apare pe acest produs. Această însemnă că produsul nu poate fi aruncat în același loc cu deșeurile casnice și că trebuie aruncat separat, pentru a fi reciclat în mod corespunzător.
- SL** Samo za razpršilnik
Direktiva o odpadni električni in elektronski opremi (WEEE)
Direktiva 2002/96/EC evropskega parlamenta in sveta. Zgornji znak, ki je prikazan na tem proizvodu pomeni, da se ta proizvod ne sme odvreči z običajnimi komunalnimi odpadki, temveč mora biti odvržen v posebna, za to določena zbirališča, da se lahko reciklira.
- SRB** Važi samo za dispenser
Direktiva broj 2002/96/EC Evropskog Parlamenta i Saveta Evrope za odlaganje električnog i elektronskog otpada. Na proizvodu stoji gornji simbol koji znači da ovaj proizvod ne treba odlagati sa redovnim otpadom, već odvojeno da bi mogao da se reciklira.

© 2010 Rubbermaid Commercial Products LLC
3124 Valley Avenue, Winchester, VA 22601
1-800-347-9800

A **NewellRubbermaid** Brand



Innovative Hygiene Solutions

www.rcpworksmarter.com



4870121 REV 02